



LP0191

**FITTING INSTRUCTIONS FOR LP0191BK LICENCE PLATE BRACKET**  
**DUCATI MONSTER 1200R 2016-**

Page | 1



**THIS KIT CONTAINS THE ITEMS PICTURED AND LABELLED BELOW.**  
**DO NOT PROCEED UNTIL YOU ARE SURE ALL PARTS ARE PRESENT.**

**Please note that the way the kit is packed does not necessarily represent the way of mounting to the bike**

THE PARTS SHOWN MAY BE REPRESENTATIVE ONLY (FOR CLARITY OF INSTRUCTIONS ONLY)

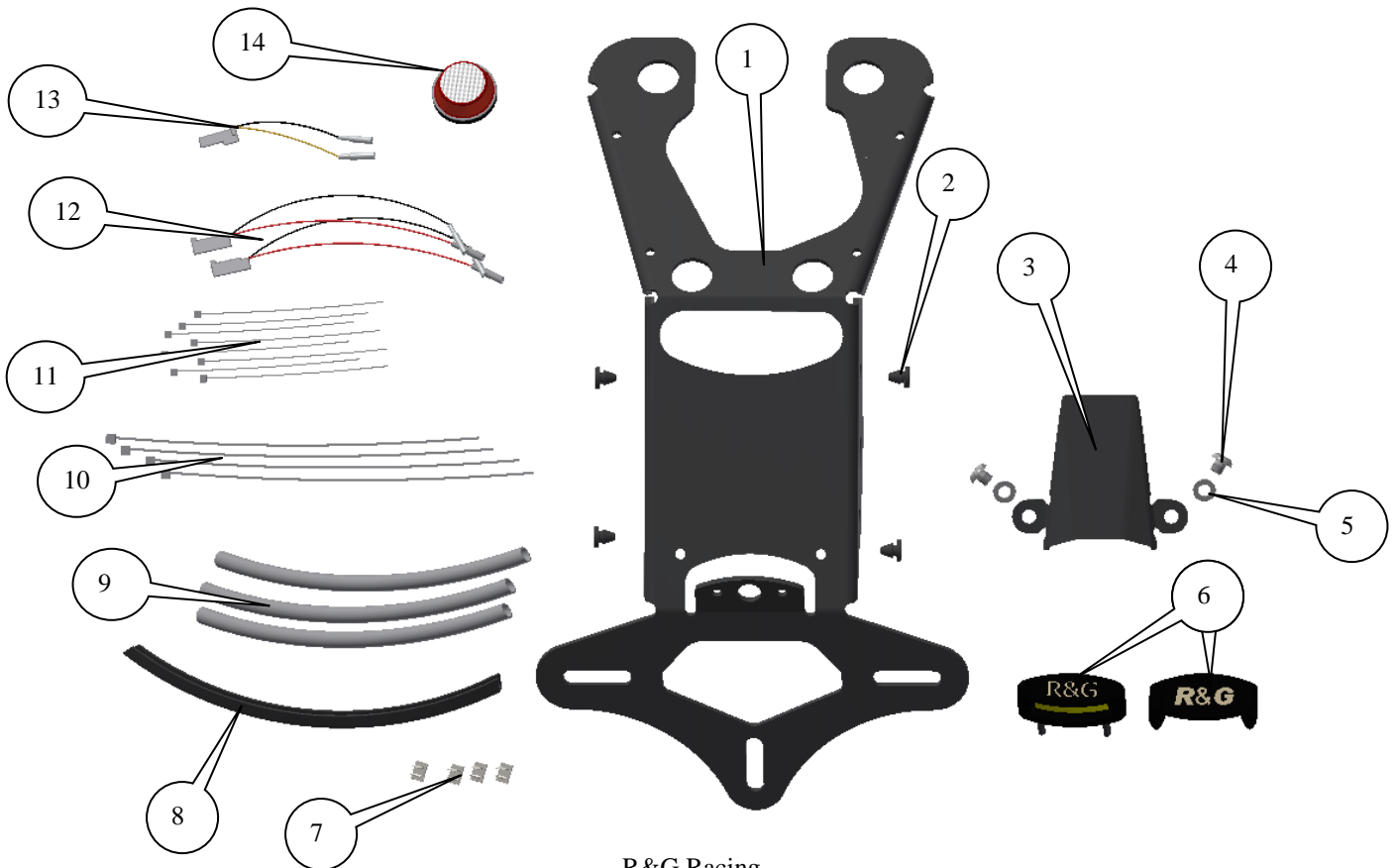

R&G Racing

Unit 1, Shelley's Lane, East Worldham, Alton, Hampshire, GU34 3AQ

Tel: +44 (0)1420 89007 Fax: +44 (0)1420 87301 [www.rg-racing.com](http://www.rg-racing.com) Email: [info@rg-racing.com](mailto:info@rg-racing.com)



LP0191

**LEGEND**

- ITEM 1 = MAIN LICENCE PLATE MOUNTING BRACKET (TB0191BK-PART 1) (x1).
- ITEM 2 = RUBBER GROMMETS (RB50-20-00FG) (x4).
- ITEM 3 = COVER (TB0191BK-PART 2) (x1).
- ITEM 4 = M5x5mm BUTTON HEAD BOLTS (x2).
- ITEM 5 = M5 WASHERS (x2).
- ITEM 6 = LICENCE PLATE ILLUMINATOR ASSEMBLY (LA0002) (x1).
- ITEM 7 = SELF ADHESIVE CABLE CLIPS (x4).
- ITEM 8 = RUBBER EDGING SEAL (SRS002) (500mm LONG) (x1).
- ITEM 9 = 180mm LENGTHS OF HEAT SHRINK (x3).
- ITEM 10 = LARGE CABLE TIES (x4).
- ITEM 11 = SMALL CABLE TIES (x8).
- ITEM 12 = INDICATOR CONNECTORS (CON0015) (x2).
- ITEM 13 = LICENCE PLATE ILLUMINATOR CONNECTOR (CON0014) (x1).
- ITEM 14 = REFLECTOR (REFL 1) (x1).

Page | 2

Please note that in cases where kits are packed with rubber washers holding the components onto the bolt – *the rubber washers should be thrown away!*

**TOOLS REQUIRED**

- Set of Metric Allen keys to include 3, 4 and 6mm A/F.
  - Electrical pliers/crimps.
  - Small amount of super glue.

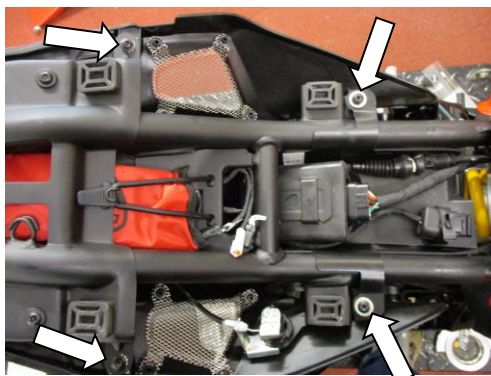

PICTURE 1

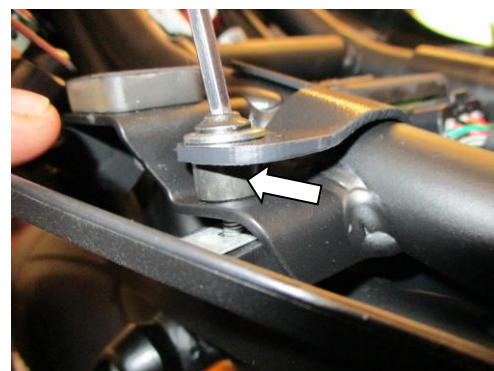

PICTURE 2

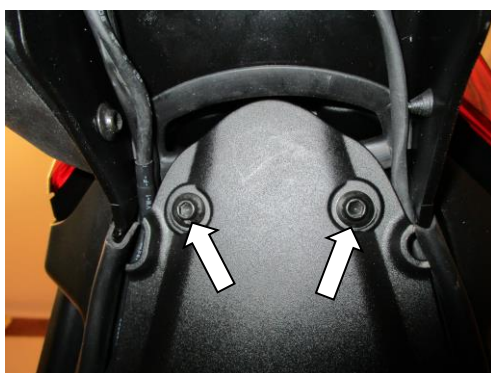

PICTURE 3



PICTURE 4



LP0191

Page | 3

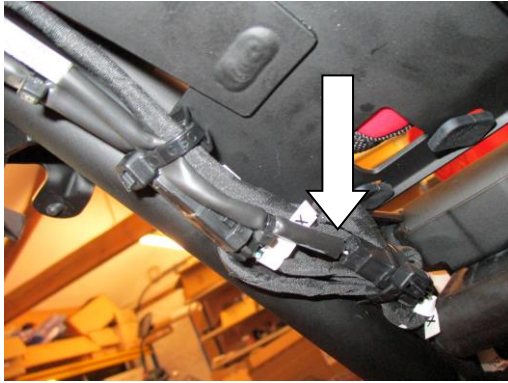

PICTURE 5

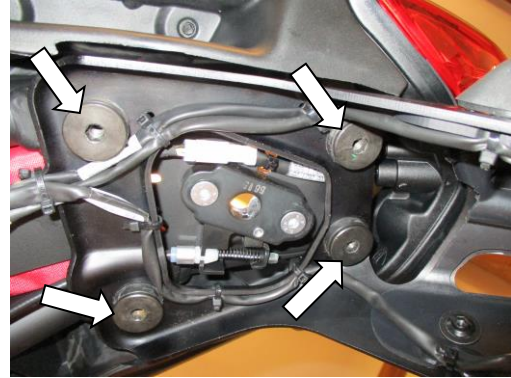

PICTURE 6



PICTURE 7



PICTURE 8

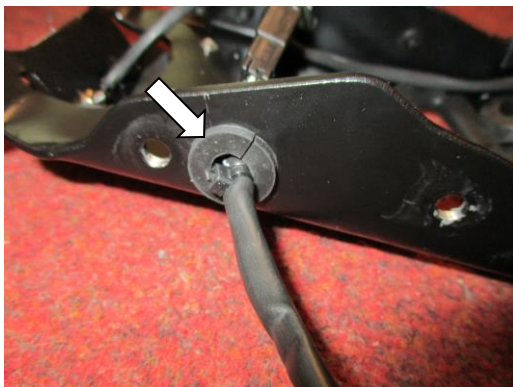

PICTURE 9



PICTURE 10





LP0191

Page | 4



PICTURE 11



PICTURE 12



PICTURE 13



PICTURE 14



PICTURE 15



PICTURE 16



LP0191

Page | 5



PICTURE 17

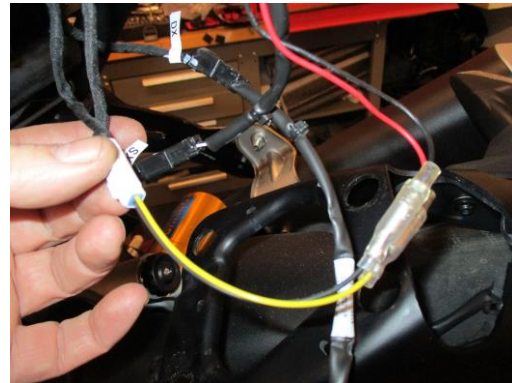

PICTURE 18

### **FITTING INSTRUCTIONS**

- Remove the seat using the keys.
- Remove the four bolts arrowed in picture 1 (be careful not to lose the spacers shown in picture 2).
- Remove the two bolts arrowed in picture 3.
- Carefully lower the under-tray as shown in picture 4.
- Disconnect the three wiring plug sockets for the licence plate illuminator and indicators as shown in picture 5 (you will have to cut the cable ties).
- Remove the four bolts arrowed in picture 6 and gently remove the original licence plate bracket.

### **If reusing the original indicators**

- Remove the two bolts arrowed in picture 7 and then remove the rubber grommet as shown in picture 8.
- Cut the cable ties securing the wiring and remove the indicator (please note which side it came off).
- Repeat the above to remove the other indicator (please note the relevant sides).
- Fit the original rubber grommets to the new licence plate bracket (item 1) as shown in picture 9.
- Fit the indicators to the new licence plate bracket (item 1) as they were mounted originally (ensure they are fitted on the correct sides).

### **If using Mini indicators**

- If using mini's, fit the indicators of choice to the new licence plate bracket (item 1) (R&G mini indicator product code RG370 for bulb type and RG371 for LED type or RG372 for Aero Style led type) through the grommet holes (please use the provided heat shrink (item 9) to protect the wiring).
- Use the four small rubber grommets (item 2) to blank the bolt holes.
- Remove the four original rubber mounting grommets as shown in picture 10.
- Cut the rubber edging strip into suitable lengths and stick in position to the cover (item 3) and the new licence plate bracket (item 1) as arrowed in pictures 11 and 12.
- Fit the four original mounting grommets to the new licence plate bracket as shown in picture 13.

R&G Racing

Unit 1, Shelley's Lane, East Worldham, Alton, Hampshire, GU34 3AQ  
Tel: +44 (0)1420 89007 Fax: +44 (0)1420 87301 [www.rg-racing.com](http://www.rg-racing.com) Email: [info@rg-racing.com](mailto:info@rg-racing.com)



LP0191

Page | 6

- Fit the new licence plate illuminator (item 6) to the new licence plate bracket (item 1) as shown in pictures 14 and 15 (please use the provided heat shrink (item 5) to protect the wiring).
- **PLEASE NOTE YOU WILL NEED TO GLUE THE LIGHT SHROUD TO THE LED LICENCE PLATE ILLUMINATOR USING SUPER GLUE.**
- Use the supplied small cable ties (item 11) and self-adhesive cable clips (item 7) to secure and tidy the wiring to the bracket as shown in picture 16.
- Offer this assembly into position as shown in picture 17.
- Using four original bolts to secure the assembly in position.
- Route the wiring as original.
- Connect the licence plate illuminator using the supplied wiring connector (item 13) to the original wiring plug socket.
- If using the original indicators use the original wiring harness (from the original licence plate bracket) to connect the indicators to the original wiring plug socket. It is a good idea to check the operation of the licence plate illuminator and indicators at this stage (if the licence plate illuminator fails to light please swap the bullet connectors over).
- If fitting the R&G Mini Indicators connect the indicators using the supplied wiring connectors (item 12) to the original wiring plug socket. Plug it into the loom to check at this stage (if operation fails, swap the bullet connections around). (Please use the heat-shrink (item 9) to protect the new indicator wires). It is a good idea at this point to turn the ignition on and check for the correct operation of all lights.
- Fit the cover (item 3) using the M5 bolts and washers (items 4 and 5).
- Use the larger cable ties (item 10) to secure the wires as original.
- Refit the under-tray as original.
- Re-fit the licence plate (it may require drilling).
- **IMPORTANT: IF FITTING A FULL-SIZE LICENCE PLATE AND PLACING IT FAR DOWN ON THE LICENCE PLATE HANGER, THERE IS A SMALL CHANCE OF THE LICENCE PLATE HITTING THE BACK WHEEL UNDER HEAVY LOAD AND OVER LARGE BUMPS IN THE ROAD. IT IS YOUR RESPONSIBILITY TO CHECK FOR THIS POSSIBILITY AND TAKE AVOIDING ACTION. FAILURE TO CHECK THIS COULD RESULT IN SERIOUS INJURY OR DAMAGE.**
- Refit the seat.
- Depending on local laws, attach enclosed red reflector (item 14) in an appropriate location.
- **Please test the indicators, rear light and licence plate illuminator before riding.**

Digital copies of these instructions are available to download from [www.rg-racing.com](http://www.rg-racing.com)

#### **GENERAL TORQUE SETTINGS**

M4 BOLT = 8Nm  
M5 BOLT = 12Nm  
M6 BOLT = 15Nm  
M8 BOLT = 20Nm  
M10 BOLT = 40Nm

ISSUE 1 15/03/2016 (NSY)

#### **CONSUMER NOTICE**

The catalogue description and any exhibition of samples are only broad indications of the Products and R&G may make design changes which do not diminish their performance or visual appeal and supplying them in such state shall conform to the order. The Buyer acknowledges no representation or warranty (other than as to title) has been given or will apply to the Products other than those in R&G's order or confirmation and the Buyer confirms it has chosen the Products as being of merchantable quality and suitable for its particular purposes. Where R&G fits the Products or undertakes other services it shall exercise reasonable skill and care and rectify any fault free of charge unless the workmanship has been disturbed. The Buyer is responsible for

R&G Racing

Unit 1, Shelley's Lane, East Worldham, Alton, Hampshire, GU34 3AQ

Tel: +44 (0)1420 89007 Fax: +44 (0)1420 87301 [www.rg-racing.com](http://www.rg-racing.com) Email: [info@rg-racing.com](mailto:info@rg-racing.com)





LP0191

ensuring that the warranty on the motorcycle is not affected by the fitting of the Products. On return of any defective Products R&G shall at its option either supply a replacement or refund the purchase money but shall not be liable if the Products have been modified or used or maintained otherwise than in accordance with R&G's or manufacturer's instructions and good engineering practice or if the defect arises from accident or neglect. Other than identified above and subject to R&G not limiting its liability for causing death and personal injury, it shall not be liable for indirect or consequential loss and otherwise its liability shall be limited to the amounts paid by the Buyer for the Products or the fitting or service concerned. These terms do not affect the Buyer's statutory rights.

Page | 7

**R&G RACING RETURNS POLICY (NON-FAULTY GOODS)**

Returns must be pre-authorized (if not pre-authorized the return will be rejected). Goods may only be returned direct to us if they were purchased direct from us (customer must prove if necessary). Otherwise to be returned to original vendor. Goods must be in re-sellable condition, in the opinion of R&G Racing. All returns are subject to a 25% restocking and handling fee (25% of the gross value exc. P&P – at the prevailing price at time of purchase). The customer must pay any and all carriage charges. No returns of discontinued products, unless within 14 days of purchase. This policy does not affect your statutory rights and does not refer to faulty goods.

R&G Racing

Unit 1, Shelley's Lane, East Worldham, Alton, Hampshire, GU34 3AQ

Tel: +44 (0)1420 89007 Fax: +44 (0)1420 87301 [www.rg-racing.com](http://www.rg-racing.com) Email: [info@rg-racing.com](mailto:info@rg-racing.com)



LP0191

**NOTICE DE MONTAGE POUR LP0191BK SUPPORT DE PLAQUE  
DUCATI MONSTER 1200R 2016-**

Page | 8



**Assurez vous que toutes les pièces soient présentes avant de procéder au montage.**

**La façon dont le kit est emballé ne correspond pas forcément à la façon de monter les pièces sur la moto.**

LES PIÈCES PRÉSENTÉES PEUVENT N'ÊTRE QUE REPRESENTATIVES, AFIN DE FACILITER ET CLARIFIER LES INSTRUCTIONS DE MONTAGE)

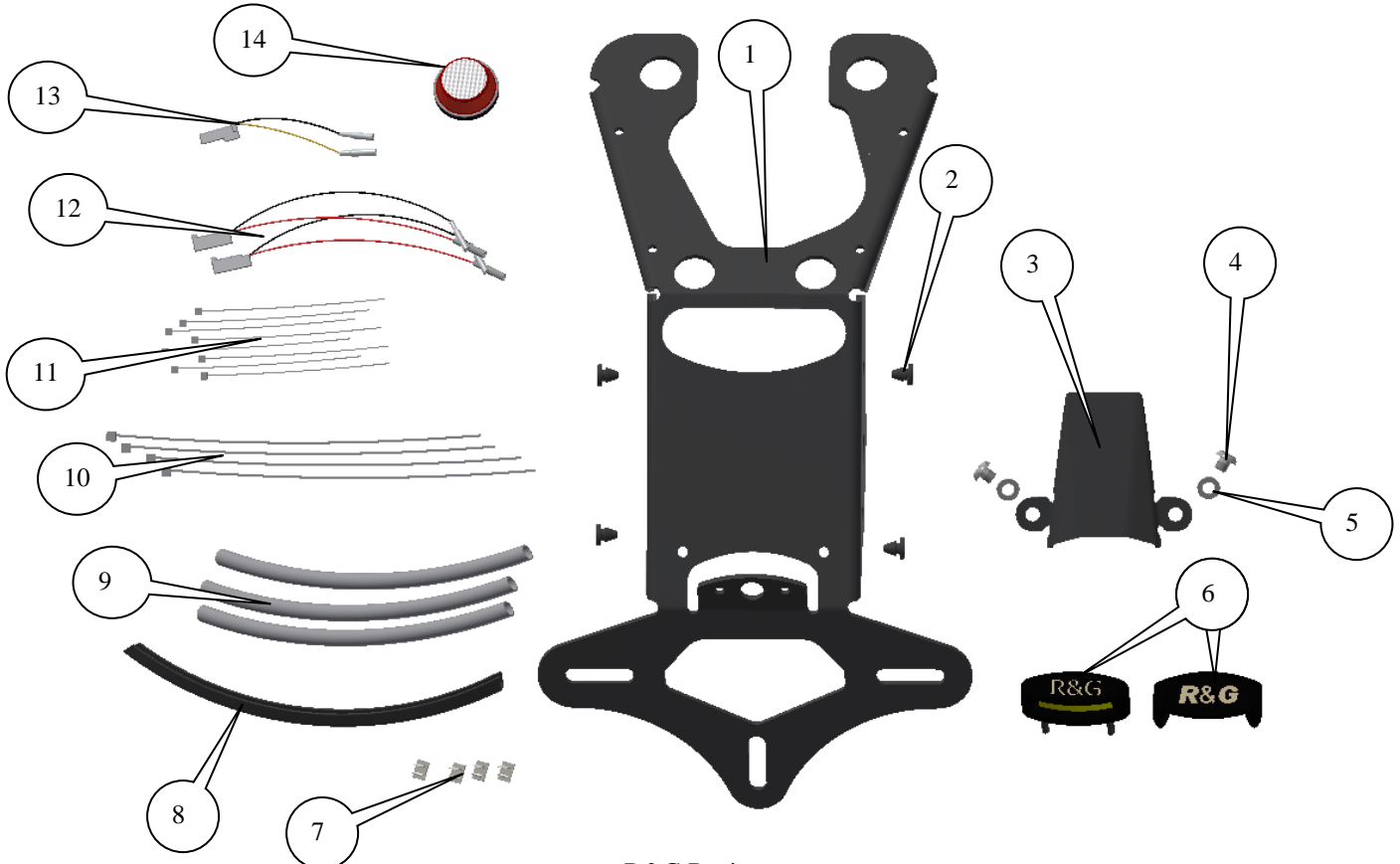

R&G Racing

Unit 1, Shelley's Lane, East Worldham, Alton, Hampshire, GU34 3AQ

Tel: +44 (0)1420 89007 Fax: +44 (0)1420 87301 [www.rg-racing.com](http://www.rg-racing.com) Email: [info@rg-racing.com](mailto:info@rg-racing.com)





LP0191

### **LEGENDE**

- ARTICLE 1 = SUPPORT DE PLAQUE PRINCIPAL (TB0191BK-PART 1) (x1).  
ARTICLE 2 = JOINTS EN CAOUTCHOUC (RB50-20-00FG) (x4).  
ARTICLE 3 = CACHE (TB0191BK-PART 2) (x1).  
ARTICLE 4 = M5x5mm BOULONS (x2).  
ARTICLE 5 = M5 RONDELLES (x2).  
ARTICLE 6 = ASSEMBLAGE FEU DE PLAQUE (LA0002) (x1).  
ARTICLE 7 = CLIPS AUTOCOLLANTS (x4).  
ARTICLE 8 = JOINT D'ETANCHEITE (SRS002) (500mm DE LONG) (x1).  
ARTICLE 9 = 180mm LONGUEURS DE THERMO RETRACTABLE (x3).  
ARTICLE 10 = COLLIERS DE SERRAGE (x4).  
ARTICLE 11 = COLLIERS DE SERRAGE (x8).  
ARTICLE 12 = CONNECTEURS DE CLIGNOTANT (CON0015) (x2).  
ARTICLE 13 = CONNECTEUR FEU DE PLAQUE (CON0014) (x1).  
ARTICLE 14 = REFLECTEUR (REFL 1) (x1).

Page | 9

Notez que si les kits sont emballés avec des rondelles en caoutchouc servant à tenir les composants, *ces rondelles doivent être jetées !*

### **OUTILS REQUIS**

- Jeu de clés Allen 3, 4, et 6mm.
  - Pincés électriques.
  - Un peu de superglue.



PHOTO 1

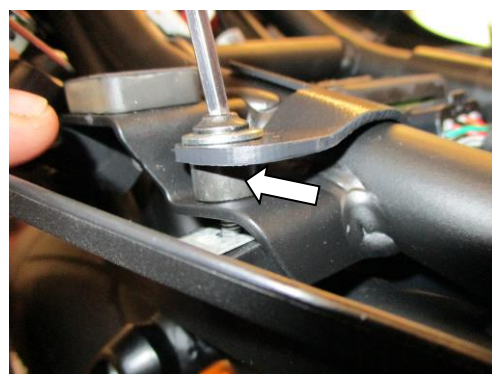
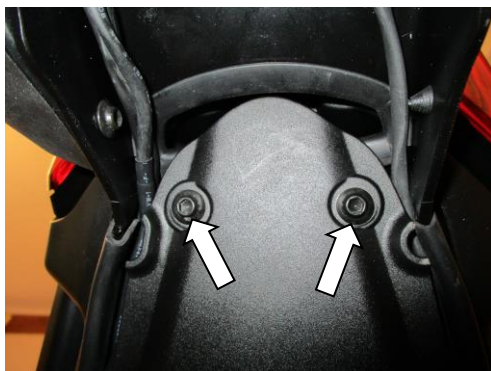

PHOTO 2



R&G Racing

Unit 1, Shelley's Lane, East Worldham, Alton, Hampshire, GU34 3AQ  
Tel: +44 (0)1420 89007 Fax: +44 (0)1420 87301 [www.rg-racing.com](http://www.rg-racing.com) Email: [info@rg-racing.com](mailto:info@rg-racing.com)



LP0191

PHOTO 3

PHOTO 4

Page | 10

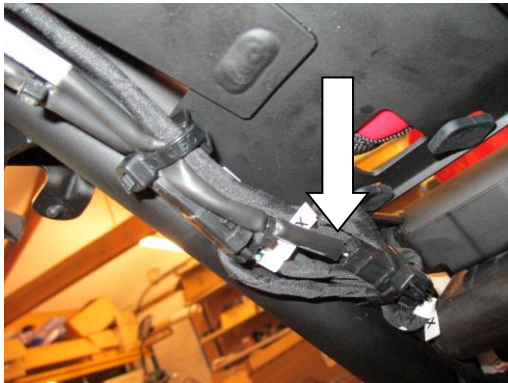

PHOTO 5

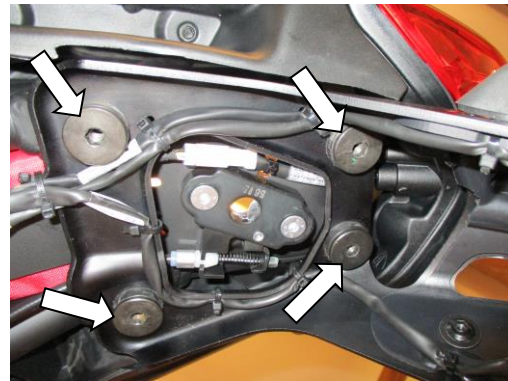

PHOTO 6



PHOTO 7



PHOTO 8

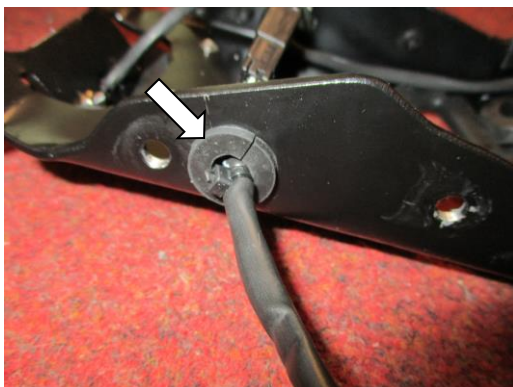

PHOTO 9



PHOTO 10





LP0191

Page | 11



PHOTO 11



PHOTO 12



PHOTO 13



PHOTO 14



PHOTO 15



PHOTO 16





LP0191

Page | 12



PHOTO 17

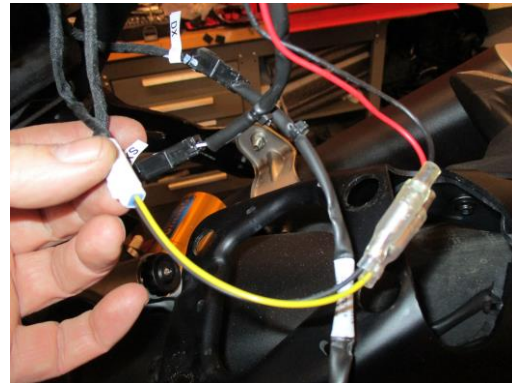

PHOTO 18

### **NOTICE DE MONTAGE**

- Enlever le siège à l'aide d'une clé.
- Enlever les 4 boulons, voir photo 1, faites attention à ce ne pas perdre les entretoises présentes sur la photo 2).
- Enlever les 2 boulons, voir photo 3.
- Abaisser le passage de roue, voir photo 4.
- Déconnecter les 3 prises de feu de plaque et clignotants, voir photo 5 (vous devrez couper les colliers).
- Enlever les 4 boulons, voir photo 6 et enlever le support de plaque d'origine.

### **Si vous réutilisez les clignotants d'origine**

- Enlever les 2 boulons, voir photo 7 puis enlever le joint en caoutchouc, voir photo 8.
- Couper les colliers qui fixent les fils puis enlever le clignotant (Notez de quel côté il s'enlève).
- Répéter la procédure pour enlever l'autre clignotant (Notez les cotés concernés).
- Monter les joints en caoutchouc d'origine sur le nouveau support de plaque (article 1), voir photo 9.
- Monter les clignotants sur le nouveau support (article 1) de la même façon qu'ils ont été enlevés à l'origine (Assurez vous qu'ils soient montés du bon côté).

### **Si vous utilisez les mini clignotants**

- Si vous utilisez les mini clignotants, monter les clignotants de votre choix sur le nouveau support de plaque (article 1) (Mini clignotant R&G code RG370 pour type ampoule et RG371 pour type LED ou RG372 pour type LED latéral) dans les trous (Utiliser la thermo rétractable fournie (article 9) pour protéger les fils).
- Utiliser les 4 petits joints en caoutchouc (article 2) pour boucher les trous de boulons.
- Enlever les 4 joints en caoutchouc, voir photo 10.
- Couper la bande en caoutchouc aux longueurs adéquates et collez les en position sur le cache (article 3) et le nouveau support de plaque (article 1), voir photos 11 et 12.

R&G Racing

Unit 1, Shelley's Lane, East Worldham, Alton, Hampshire, GU34 3AQ

Tel: +44 (0)1420 89007 Fax: +44 (0)1420 87301 [www.rg-racing.com](http://www.rg-racing.com) Email: [info@rg-racing.com](mailto:info@rg-racing.com)



LP0191

Page | 13

- Monter les 4 supports en caoutchouc sur le nouveau support de plaque, voir photo 13.
- Monter le nouveau feu de plaque (article 6) sur le support de plaque (article 1), voir photos 14 et 15 (Utiliser la thermo rétractable fournie (article 5) pour protéger les fils).
- **VOUS DEVREZ COLLER LE LINCEUL AU FEU DE PLAQUE LED EN UTILISANT LA SUPER GLUE .**
- Utiliser les petits colliers fournis (article 11) et les clips autocollants (article 7) pour fixer et serrer les fils sur leur support, voir photo 16.
- Monter l'ensemble en position, voir photo 17.
- Utiliser les 4 boulons d'origine pour fixer l'ensemble en position.
- Router les fils comme à l'origine.
- Connecter le feu de plaque en utilisant le connecteur fourni (article 13) sur la prise d'origine.
- Si vous utilisez les clignotants d'origine, utilisez le harnais de fils d'origine (du support de plaque d'origine) pour connecter les clignotants sur la prise d'origine. Vérifiez que le feu de plaque et les clignotants fonctionnent correctement à ce stade (Si le feu de plaque échoue, svp tournez les connecteurs).
- Si vous monter les mini clignotants R&G, connectez les clignotants en utilisant les connecteurs fournis (article 12) à la prise d'origine. Brancher dans le linceul pour vérifier l'éclairage à ce stade (si échec, tournez les connecteurs). (Utiliser de la thermo rétractable (article 9) pour protéger les fils). A ce stade, mettez le contact et vérifiez que les feux fonctionnent.
- Monter le cache (article 3 en utilisant les boulons M5 et rondelles (articles 4 et 5).
- Utiliser les colliers de serrage les plus larges (article 10) pour fixer les fils comme à l'origine.
- Remonter le passage de roue comme à l'origine.
- Remettre la plaque d'immatriculation (Peut nécessiter un perçage).
- **IMPORTANT: Si vous installez une grosse plaque, il y a un risque que la plaque entre en contact avec la roue arrière en cas de choc sur la route (bosse, grosse charge etc...). Il est de votre responsabilité de vérifier que cela ne puisse pas se produire. Ne pas effectuer ces vérifications peut entraîner des dommages ainsi que des blessures graves pour le pilote.**
- Remettre le siège.
- Selon la loi locale, attachez le réflecteur (article 13) fourni à son emplacement approprié
- Vérifiez que les clignotants et les feux de plaque fonctionnent bien avant de prendre la route.

Notice disponible sur [www.rg-racing.com](http://www.rg-racing.com)

### **COUPLES DE SERRAGE RECOMMANDÉS :**

M4 BOULON = 8Nm  
M5 BOULON = 12Nm  
M6 BOULON = 15Nm  
M8 BOULON = 20Nm  
M10 BOULON = 40Nm

ISSUE 1 15/03/2016 (NSY)

#### **CONSUMER NOTICE**

The catalogue description and any exhibition of samples are only broad indications of the Products and R&G may make design changes which do not diminish their performance or visual appeal and supplying them in such state shall conform to the order.

R&G Racing

Unit 1, Shelley's Lane, East Worldham, Alton, Hampshire, GU34 3AQ

Tel: +44 (0)1420 89007 Fax: +44 (0)1420 87301 [www.rg-racing.com](http://www.rg-racing.com) Email: [info@rg-racing.com](mailto:info@rg-racing.com)



LP0191

Page | 14

The Buyer acknowledges no representation or warranty (other than as to title) has been given or will apply to the Products other than those in R&G's order or confirmation and the Buyer confirms it has chosen the Products as being of merchantable quality and suitable for its particular purposes. Where R&G fits the Products or undertakes other services it shall exercise reasonable skill and care and rectify any fault free of charge unless the workmanship has been disturbed. The Buyer is responsible for ensuring that the warranty on the motorcycle is not affected by the fitting of the Products. On return of any defective Products R&G shall at its option either supply a replacement or refund the purchase money but shall not be liable if the Products have been modified or used or maintained otherwise than in accordance with R&G's or manufacturer's instructions and good engineering practice or if the defect arises from accident or neglect. Other than identified above and subject to R&G not limiting its liability for causing death and personal injury, it shall not be liable for indirect or consequential loss and otherwise its liability shall be limited to the amounts paid by the Buyer for the Products or the fitting or service concerned. These terms do not affect the Buyer's statutory rights.

**R&G RACING RETURNS POLICY (NON-FAULTY GOODS)**

Returns must be pre-authorized (if not pre-authorized the return will be rejected). Goods may only be returned direct to us if they were purchased direct from us (customer must prove if necessary). Otherwise to be returned to original vendor. Goods must be in re-sellable condition, in the opinion of R&G Racing. All returns are subject to a 25% restocking and handling fee (25% of the gross value exc. P&P – at the prevailing price at time of purchase). The customer must pay any and all carriage charges. No returns of discontinued products, unless within 14 days of purchase. This policy does not affect your statutory rights and does not refer to faulty goods.

R&G Racing

Unit 1, Shelley's Lane, East Worldham, Alton, Hampshire, GU34 3AQ

Tel: +44 (0)1420 89007 Fax: +44 (0)1420 87301 [www.rg-racing.com](http://www.rg-racing.com) Email: [info@rg-racing.com](mailto:info@rg-racing.com)